

Mechanical Installation

Observe the following safety guidelines before installing or removing your CLASSIC switch/transmitter:

- Use proper eye protection and any other safety equipment as required by your installation site.
 - Check electrical power to ensure that all power has been disconnected and “locked out.”
 - Ensure the process tank or line pressures are “zero.”
 - Protect yourself against accidental release of steam, hot water, acids and other potentially hazardous media.
 - Follow all safety precautions as specified for your installation site and local codes.
1. Before installing your CLASSIC, coat the sensor threads with facility-approved lubricant or sealant to prevent threads from binding.
 2. Extra caution should be taken not to over-tighten the sensor threads while installing.
 3. Install the CLASSIC, taking into account the orientation of the sensor as described below.
 4. Keep in mind the need for easy access, safety of personnel and a suitable environment for the CLASSIC. In general, install the CLASSIC so as to minimize its exposure to vibration, shock, and extreme temperature fluctuations.

Sensor Orientation

The CLASSIC sensor is marked with the universal symbol . This surface should be flat up and level in a horizontal flow application only. Refer to **Figures 1** and **2** for flow and level applications; this surface of the hex should be parallel to the direction of change in the process.

**Figure 1 -
Sensor Orientation for
Horizontal Flow**

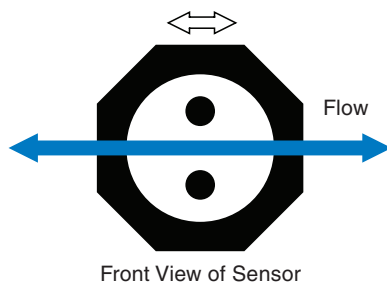

Horizontal Pipe: Side Mount

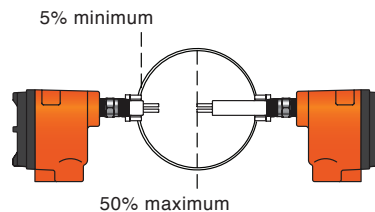

Top/Bottom Mount

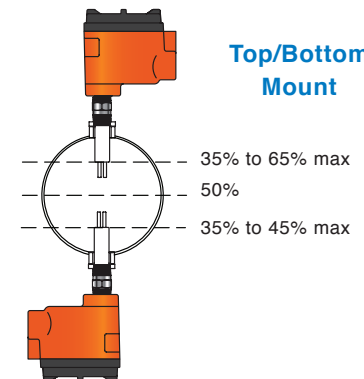

**Figure 2 -
Sensor Orientation for Vertical
Flow**

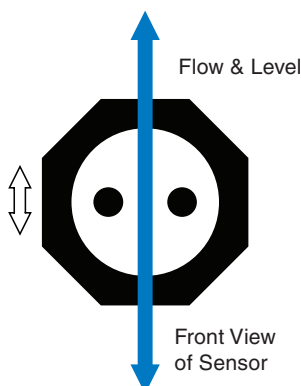

**Sensor Positioning,
Horizontal Pipe**

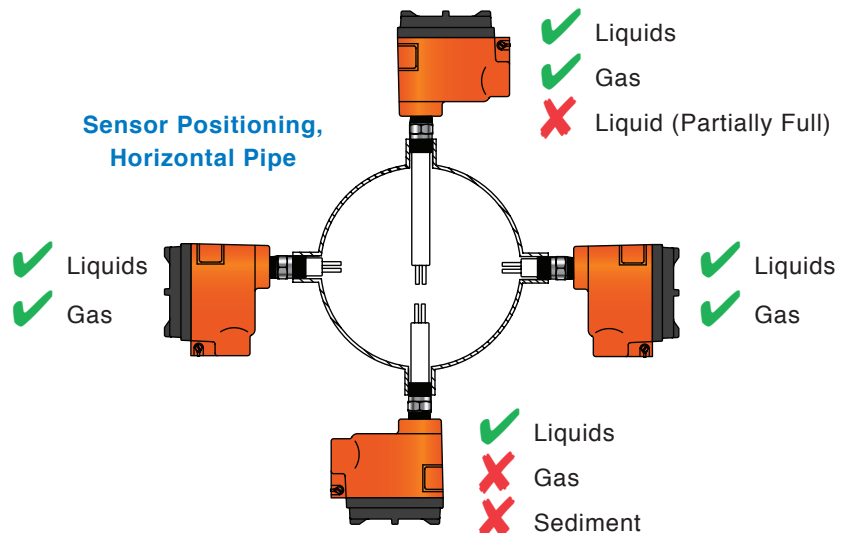

To configure or adjust the CLASSIC, perform these steps in the order indicated.
STEP 1 - Perform changes to Heater Power on Setting 7, then adjust Scaling on Settings 10 & 11
STEP 2 - Push RUN and verify the Thermal Signal is within the unscaled or new scaled view.
STEP 3 - Perform changes to Relay operation on settings 1 & 2
STEP 4 - Perform changes to Set Points on settings 4 & 5



- SET** → **RELAY 1** (LED SOLID) Select the coil operation to energize lower or higher than set point.
 Press 1x Factory Default: **LOWER**

 - ← Energize Lower than Setpoint
 - Energize Higher than Setpoint
- SET** → **RELAY 2** (LED SOLID) Select the coil operation to energize lower or higher than set point.
 Press 2x Factory Default: **LOWER**

 - ← Energize Lower than Setpoint
 - Energize Higher than Setpoint
- SET** → **FAULT** (LED SOLID) Select the fault action to be either Fail low at 3.0 mA or Fail high at 21 mA
 Press 3x Factory Default: **3.0 mA**

 - ← 3.0 mA Output Fault
 - 21.0 mA Output Fault
- SET** → **Set Point 1** (LED SOLID) Select a Thermal Signal Set Point for Relay 1
 Press 4x Factory Default: **25%**

 - ← Decrease Set Point
 - Increase Set Point
- SET** → **Set Point 2** (LED SOLID) Select a Thermal Signal Set Point for Relay 2
 Press 5x Factory Default: **75%**

 - ← Decrease Set Point
 - Increase Set Point
- SET** → **BYPASS** (LED SOLID) Select an amount of time for the switch to return to RUN mode. Increments of 5 seconds.
 Press 6x Factory Default: **0 Seconds**

 - ← Decrease Bypass Time
 - Increase Bypass Time
- SET** → **RELAY 1** (LED FLASHING) Select a Heater Power setting. This directly affects the sensitivity to flow.
 Press 7x Factory Default: **75%**

 - ← Decrease Heater Power
 - Increase Heater Power
- SET** → **RELAY 2** (LED FLASHING) Select a Node Address for Modbus Comms. Software Rec is also identified on the left LEDs
 Press 8x Factory Default: **1**

 - ← Decrease Node Address
 - Increase Node Address
- SET** → **FAULT** (LED FLASHING) Select the action of the 4-20 mA Output to either Reverse or Forward acting.
 Press 9x Factory Default: **Forward**

 - ← Forward Acting mA Output
 - Reverse Acting mA Output
- SET** → **Set Point 1** (LED FLASHING) Select a zero percent thermal signal for the LRV scaled view.
 Press 10x Factory Default: **0%**

 - ← Decrease LRV
 - Increase LRV
- SET** → **Set Point 2** (LED FLASHING) Select a one hundred thermal signal for the URV Scaled View
 Press 11x Factory Default: **100%**

 - ← Decrease URV
 - Increase URV

How to Enter, Scroll & Exit the Configuration Menu

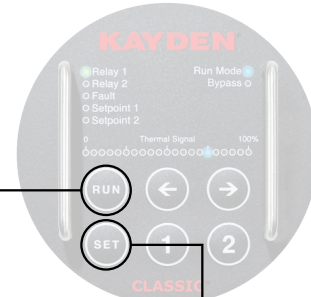

Press RUN to exit Setup and return to RUN MODE.

Press SET to enter Configuration Mode. To access all 11 menu options, press SET repeatedly.

Note: If Bypass is turned on, the RUN MODE will not start until the selected time ends

How to Perform Factory Reset

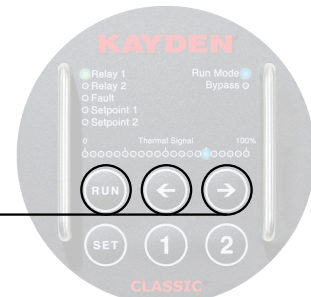

Press & Hold RUN + LEFT ARROW + RIGHT ARROW until all LEDs flash or run back and forth.

Previous configurations will be lost and the unit will return to factory defaults.

Relays will actuate and/or de-actuate during reset.

Consult Troubleshooting (Section 7) in Product Manual for full details.

Quick Check Buttons

***MUST BE IN RUN MODE**



- A - Press & Hold RUN to view Software Rev & Modbus Node Address
- B - Press & Hold LEFT ARROW to view LRV and URV.
- C - Press & Hold RIGHT ARROW to view Thermal Signal on Unscaled Bar Graph
- D - Press & Hold 1 to view Set Point 1
- E - Press & Hold 2 to view Set Point 2



CLASSIC 800 Display Panel

Display Panel Indicators:

- Relay 1** On steady when Relay 1 is energized
- Relay 2** On steady when Relay 2 is energized
- Fault** Indicates a self-test error or fault condition
- Set Point 1** On steady when viewing Set Point 1
- Set Point 2** On steady when viewing Set Point 2
- Run Mode** Flashing when switch is operating
- Bypass** Flashing when the Start-up Bypass Timer is active
- Thermal Signal** Displays Thermal Signal

The Thermal Signal increases as:

- Flow** The flow rate increases
- Level** The sensor is submerged
- Interface** The sensor is submerged by the second liquid of greater thermal conductivity

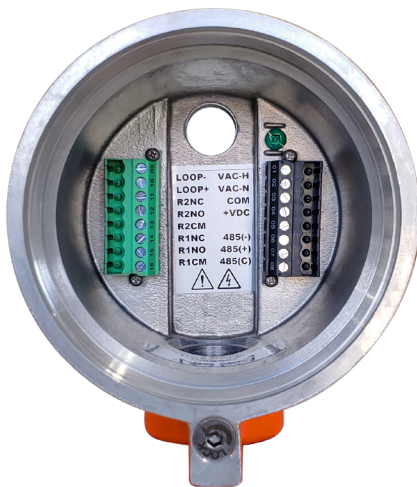

Mounting Base Plate / Terminal Assembly

RUN MODE - Run Mode LED is 'Flashing'	
RUN	Press and hold to view the Software Revision and Node Address
SET	Press and release to enter Set Mode (see table below)
Left Arrow	Press and hold to view the LRV and URV on Unscaled Bar Graph
Right Arrow	Press and hold to view Thermal Signal data on Unscaled Bar Graph
1	Press and hold to view Set Point 1 on Bar Graph
2	Press and hold to view Set Point 2 on Bar Graph

SET MODE - Run Mode LED is 'Off'	
RUN	Press and release to exit Set Mode and return to Run Mode
SET	Press and release to proceed to next step of Set Mode
Left Arrow	Adjust selection as per Set Mode function
Right Arrow	Adjust selection as per Set Mode function
1	No function in Set Mode
2	No function in Set Mode

Mounting Base Plate Wire Positions	
09 - LOOP -	01 - VAC-H
10 - LOOP +	02 - VAC-N
11 - R2NC	03 - COM
12 - R2NO	04 - +VDC
13 - R2CM	05 - 485-T
14 - R1NC	06 - 485-A (-)
15 - R1NO	07 - 485-B (+)
16 - R1CM	08 - 485-C

CAUTION

Installation, connection and maintenance must be carried out by expert technicians who have read these operating instructions. These operating instructions include all-important information required for the installation and operation of this product. They supplement the full Product Manual, and the relevant national regulations with respect to the equipment as well as with the maintenance activities.

POWER, AC/DC

Either AC or DC voltage can be used to power the CLASSIC:

- For AC power, connect the HOT line to VAC-H, the NEUTRAL to VAC-N and the GROUND wire to the green grounding screw, also indicated by the ground symbol.
- For DC Power, connect the positive voltage to +VDC and the common or negative to COM.

CAUTION

Never power on the circuits in a potentially explosive area without first installing the enclosure cover.

Always lock the cover in place. This may be required by your local safety or electrical code.

RELAY OUTPUTS The CLASSIC features two independent set points each with its own mechanical relay for output. The connections for the contacts of these relays are:	
R1COM	Common or pole contact for Relay 1
R1NC	Normally closed contact for Relay 1 when the coil is not energized
R1NO	Normally open contact for Relay 1 when the coil is not energized
R2COM	Common or pole contact for Relay 2
R2NC	Normally closed contact for Relay 2 when the coil is not energized
R2NO	Normally open contact for Relay 2 when the coil is not energized

NOTE: For fail-safe installations, the desirable relay state is usually energized and the circuit closed. Use the normally open contacts for fail-safe installations since they are closed when the relay is energized.

MAINTENANCE

Your Kayden instrument requires very little maintenance as there are no moving parts.

Without detailed knowledge of the environment parameters of the application surroundings and process data media, we cannot make specific recommendations for periodic inspection, cleaning, or testing procedures. we do however suggest general guidelines for

maintenance (see the CLASSIC Product Manual). Use operating experience to establish the frequency of each type of maintenance.

CALIBRATION

The CLASSIC does not require any calibration for use as a switch/transmitter. Once properly setup, the CLASSIC will be as stable and repeatable as the process in which it is installed. It may be necessary to check or repeat the setup procedure if the process changes dramatically over time.

HEATER POWER

The CLASSIC uses a constant power heater (2 Watt maximum), that can be set between 0 - 100% in 5% increments.

- Since the energy added by the heater is used in determining the Thermal Signal, altering the amount of heat changes the Thermal Signal.
- If the heater power is changed more than 5% (1 LED) this may require the 0% & 100% Thermal Signal to be similarly adjusted in order not to lose sensitivity and reaction time.
- The Factory Default Heater Power setting of 75% (1.5 watts) is suitable for most Flow applications with Hydro-carbons.
- **RECOMMENDED HEATER POWER SETTINGS:**
 - **30 - 60% heater power (7-13 LEDs)** - Air or Gas (Flow) (depending on velocity)
 - **60 - 75% heater power (13-16 LEDs)** - Oil or Hydrocarbon based liquids (Flow, Level & Interface)
 - **80 - 100% heater power (17-21 LEDs)** - Water or non-viscous liquids (Flow, Level & Interface)

The faster the flow rate (velocity) the more heat required. In level applications the amount of heat, in part, determines the reaction time.

The CLASSIC 800 Series has a “Smart Heater” function (see the “**Classic 800 Product Manual**”). If a heater operates constantly in a no flow or dry condition, a “Thermal Offset” can occur. This means the heater may affect the reading from the reference RTD. The microprocessor will automatically reduce the heater power setting to a lower power rating when the probe is “dry” or in a “no-flow” condition. When the process media touches the sensors, or flow begins again, the original heater power setting is restored.

KAYDEN[®]
Helping the World Switch[®]

Kayden Instruments
 3364-114th Avenue S.E. Calgary, Alberta, Canada T2Z 3V6
Tel: +1 403 253 1423 **Web:** kayden.com
 DOC#: QG-800-005 **Effective: February 2025** Supercedes: January 2025
 QG-800-005-[006]

